

Keysight Technologies E8267D PSG Vector Signal Generator

Data Sheet





Introduction

The Keysight E8267D is a fully-synthesized signal generator with high output power, low phase noise, and I/Q modulation capability.

Specifications apply over a 0 to 55 °C range, unless otherwise stated, and apply after a 45 minute warm-up time. With vector modulation on, specifications apply after executing I/Q calibration with the instrument maintained within ± 5 °C of the calibration temperature unless otherwise stated. Supplemental characteristics, denoted as typical, nominal, or measured, provide additional (non-warranted) information at 25 °C, which may be useful in the application of the product.

Unless otherwise noted, this data sheet applies to units with serial numbers ending with 50420000 or greater.

Definitions

Specifications (spec): Represents warranted performance for instruments with a current calibration.

Typical (typ): Represents characteristic performance which is non-warranted. Describes performance that will be met by a minimum of 80% of all products.

Nominal (nom): Represents characteristic performance which is non-warranted. Represents the value of a parameter that is most likely to occur; the expected mean or mode of all instruments at room temperature (approximately 25 °C).

Measured: Represents characteristic performance which is non-warranted. Represents the value of a parameter measured on an instrument during design verification.

Table of Contents

Specifications	4
Frequency	4
Step (digital) sweep	5
Ramp (analog) sweep	6
Output	7
Spectral purity	10
Frequency modulation	16
Phase modulation	16
Amplitude modulation	18
External modulation inputs	18
Internal modulation source	18
Wideband AM	19
Pulse modulation	19
Internal pulse generator	20
Simultaneous modulation	20
Vector modulation	21
Wideband external differential I/Q inputs	22
Internal baseband generator, arbitrary waveform mode	24
Internal baseband generator, real-time mode	27
Calibrated AWGN (Option 403)	29
Remote programming	29
General specifications	30
Input/Output Descriptions	31
Front panel connectors	31
Rear panel connectors	32
Auxiliary I/O connector	33
Options, Accessories, and Related Products	34
Related Keysight Literature	36
Web Resources	36

Specifications

Frequency			
Range	Specified range	Tunable range	
Option 513	250 kHz to 13 GHz	100 kHz to 13 GHz	
Option 520	250 kHz to 20 GHz	100 kHz to 20 GHz	
Option 532	250 kHz to 31.8 GHz	100 kHz to 31.8 GHz	
Option 544	250 kHz to 44 GHz	100 kHz to 44 GHz	
Resolution			
CW	0.001 Hz		
All sweep modes ¹	0.01 Hz		
Switching speed ^{2, 3, 4}	Standard	Opt UNX	Opt UNY
I/Q modulation off	< 16 ms (typ)	< 16 ms (typ)	< 26 ms (typ)
I/Q modulation on	< 24 ms (typ)	< 24 ms (typ)	< 34 ms (typ)
Phase offset	Adjustable in nominal 0.1° increments		
Frequency bands	Frequency range	N ⁵	
1	250 kHz to 250 MHz	1/8	
2	> 250 to 500 MHz	1/16	
3	> 500 MHz to 1 GHz	1/8	
4	> 1 to 2 GHz	1/4	
5	> 2 to 3.2 GHz	1/2	
6	> 3.2 to 10 GHz	1	
7	> 10 to 20 GHz	2	
8	> 20 to 28.5 GHz	3	
9	> 28.5 to 44 GHz	5	
Accuracy	± [(time since last adjustment x aging rate) + temperature effects + line voltage effects + calibration accuracy]		
Internal timebase reference oscillator (OCXO)			
Aging rate ⁶	< ± 3 x 10 ⁻⁸ /year or < ± 2.5 x 10 ⁻¹⁰ /day after 30 days		
Initial achievable calibration accuracy	< ± 4 x 10 ⁻⁸		
Temperature effects (typ)	< ± 4.5 x 10 ⁻⁹ from 0 to 55 °C		
Line voltage effects (typ)	< ± 2 x 10 ⁻¹⁰ for ± 10% change		

1. In ramp sweep mode (Option 007), resolution is limited with narrow spans and slow sweep speeds. Refer to ramp sweep specifications for more information.
2. Time from GPIB trigger to frequency within 0.1 ppm of final frequency above 250 MHz or within 100 Hz below 250 MHz. CW switching speed to within 0.05% of final frequency is ≥ 5 ms (nom).
3. Add 12 ms (typ) when switching from greater than 3.2 GHz to less than 3.2 GHz.
4. With Option 1EH low band harmonic filters off. With the 1EH filters turned on, add 4 ms.
5. N is a factor used to help define certain specifications within the document.
6. Not verified by Keysight N7800A TME Calibration and Adjustment Software. Daily aging rate may be verified as a supplementary chargeable service, on request.

External reference			
Frequency	10 MHz only		
Lock range	± 1.0 ppm		
Reference output			
Frequency	10 MHz		
Amplitude	> +4 dBm into 50 Ω load (typ)		
External reference input			
Amplitude	5 dBm ± 5 dB ¹		
Input impedance	50 Ω (nom)		
Step (digital) sweep			
Operating modes			
	Step sweep of frequency or amplitude or both (start to stop)		
	List sweep of frequency or amplitude or both (arbitrary list)		
Sweep range			
Frequency sweep	Within instrument frequency range		
Amplitude sweep	Within attenuator hold range (see "Output" section)		
Dwell time			
	1 ms to 60 s		
Number of points			
Step sweep	2 to 65535		
List sweep	2 to 1601 per table		
Triggering			
	Auto, external, single, or GPIB		
Settling time			
	Standard	Opt UNX	Opt UNY
Frequency ²	< 9 ms (typ)	< 9 ms (typ)	< 24 ms (typ)
Amplitude	< 5 ms (typ)	< 5 ms (typ)	< 5 ms (typ)

1. To optimize phase noise use 5 dBm ± 2 dB.

2. 19 ms (typ) when stepping from greater than 3.2 GHz to less than 3.2 GHz.

Ramp (analog) sweep (Option 007) ¹			
Operating modes			
	<ul style="list-style-type: none"> – Synthesized frequency sweep (start/stop), (center/span), (swept CW) – Power (amplitude) sweep (start/stop) – Manual sweep – RPG control between start and stop frequencies – Alternate sweep – Alternates successive sweeps between current and stored states 		
Sweep span range	Settable from minimum ² to full range		
Maximum sweep rate	Start frequency	Maximum sweep rate	Max span for 100 ms sweep
	250 kHz to < 0.5 GHz	25 MHz/ms	2.5 GHz
	0.5 to < 1 GHz	50 MHz/ms	5 GHz
	1 to < 2 GHz	100 MHz/ms	10 GHz
	2 to < 3.2 GHz	200 MHz/ms	20 GHz
	≥ 3.2 GHz	400 MHz/ms	40 GHz
Frequency accuracy	± 0.05% of span ± timebase (at 100 ms sweep time, for sweep spans less than maximum values given above). Accuracy improves proportionally as sweep time increases ³		
Sweep time (forward sweep, not including bandswitch and retrace intervals)			
Manual mode	Settable 10 ms to 200 seconds		
Resolution	1 ms		
Auto mode	Set to minimum value determined by maximum sweep rate and 8757D setting		
Triggering	Auto, external, single, or GPIB		
Markers	10 independent continuously variable frequency markers		
Display	Z-axis intensity or RF amplitude pulse		
Functions	M1 to center, M1/M2 to start/stop, marker delta		
Two-tone (master/slave) measurements ⁴	Two PSGs can synchronously track each other, with independent control of start/stop frequencies		
Network analyzer compatibility	Compatible with Keysight 8757D scalar network analyzer. Also useable with Keysight 8757A/C/E scalar network analyzers for making basic swept measurements. ⁵		

1. During ramp sweep operation, AM, FM, phase modulation, and pulse modulation are useable but performance is not specified; wideband AM and I/Q modulation are not useable.
2. Minimum settable sweep span is proportional to carrier frequency and sweep time. Actual sweep span may be slightly different than desired setting for spans less than $[0.00004\% \text{ of carrier frequency or } 140 \text{ Hz}] \times [\text{sweep time in seconds}]$. Actual span will always be displayed correctly.
3. Typical accuracy for sweep times > 100 ms can be calculated from the equation: $[(0.005\% \text{ of span})/(\text{sweep time in seconds})] \pm \text{timebase}$. Accuracy is not specified for sweep times < 100 ms.
4. For master/slave operation use Keysight part number 8120-8806 master/slave interface cable.
5. GPIB system interface is not supported with 8757A/C/E, only with 8757D. As a result, some features of 8757A/C/E, such as frequency display, pass-through mode, and alternate sweep, do not function with PSG signal generators.

Output

Minimum settable output power	-130 dBm		
Maximum output power (dBm) ¹	Spec (Typ)		
Frequency range ²	CW	Standard I/Q ³	Wideband I/Q ⁴
Options 513 and 520			
10 to 250 MHz (filters on)	+15 (+17)	+15 (+16)	+11 (+15)
> 0.25 to 2 GHz (filters on)	+16 (+17)	+16 (+17)	+14 (+16)
250 kHz to 10 MHz	+14 (+17)	+14 (+17)	(+14)
> 10 to < 60 MHz	+16 (+19)	+16 (+19)	+14 (+17)
60 to 400 MHz	+20 (+21)	+20 (+21)	+18 (+21)
> 0.4 to 3.2 GHz	+21 (+23)	+20 (+22)	+18 (+20)
> 3.2 to 10 GHz	+18 (+23)	+18 (+21)	+12 (+16)
> 10 to 20 GHz	+18 (+22)	+18 (+21)	+12 (+16)
Options 532 and 544			
10 to 250 MHz (filters on)	+14 (+16)	+14 (+16)	+9 (+12)
> 0.25 to 2 GHz (filters on)	+15 (+16)	+15 (+16)	+9 (+13)
250 kHz to 10 MHz	+13 (+16)	+13 (+17)	(+13)
> 10 to < 60 MHz	+15 (+18)	+15 (+17)	+13 (+16)
60 to 400 MHz	+19 (+21)	+18 (+20)	+17 (+20)
> 0.4 to 3.2 GHz	+20 (+22)	+17 (+20)	+17 (+19)
> 3.2 to 10 GHz	+14 (+21)	+14 (+21)	+9 (+13)
> 10 to 20 GHz	+14 (+18)	+14 (+18)	+8 (+14)
> 20 to 32 GHz	+14 (+18)	+14 (+18)	(+14)
> 32 to 40 GHz	+12 (+18)	+12 (+16)	(+13)
> 40 to 44 GHz	+10 (+13)	+10 (+15)	(+13)

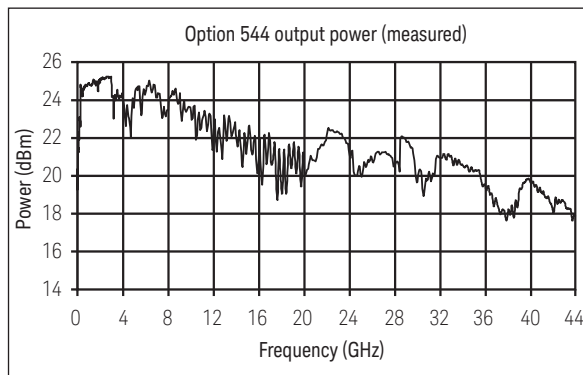
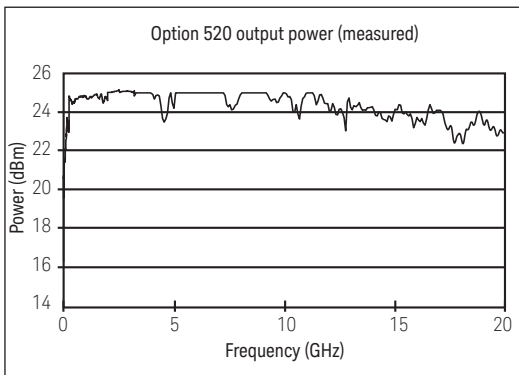

Maximum available power in CW mode (measured)

1. Maximum power specifications are warranted from 15 to 35 °C. From 0 to 15 °C, the performance is typically the same as the warranted specification. From 35 to 55 °C, the performance is typically 2 dB less than the warranted specification.
2. With Option 1EH low-pass filters below 2 GHz switched off, unless otherwise specified. Specifications above 2 GHz apply with filters on or off.
3. Applies when using the standard I/Q inputs or the internal baseband generator (Option 602) and $\sqrt{(I^2 + Q^2)} \geq 0.5 V_{rms}$.
4. Applies when using the wideband external differential I/Q inputs (Option 016) and $\sqrt{(I^2 + Q^2)} \geq 0.2 V_{rms}$.

Step attenuator ¹		0 to 115 dB in 5 dB steps		
Attenuator hold range				
Minimum		From -15 dBm to maximum specified output power with step attenuator in 0 dB position; can be offset using step attenuator		
Amplitude switching speed				
ALC on		< 6 ms (typ) ²		
ALC off		< 10 ms (typ) (not including power search) ³		
Level accuracy ⁴ (dB)	> +10 dBm	+10 to -10 dBm	< -10 to -70 dBm	< -70 to -90 dBm
250 kHz to 2 GHz	± 0.6	± 0.6	± 0.7	± 0.8
> 2 to 20 GHz	± 0.8	± 0.8	± 0.9	± 1.0
> 20 to 32 GHz	± 1.0	± 0.9	± 1.0	± 1.7
> 32 to 44 GHz	± 1.0	± 0.9	± 1.5	± 2.0
CW level accuracy with I/Q modulation (With PRBS modulated data) (relative to CW)				
With ALC on				
QAM or QPSK formats ⁵		± 0.2 dB		
Constant-amplitude formats (FSK, GMSK, etc)		± 0.2 dB		
With ALC off ⁶				
		± 0.2 dB (typ)		

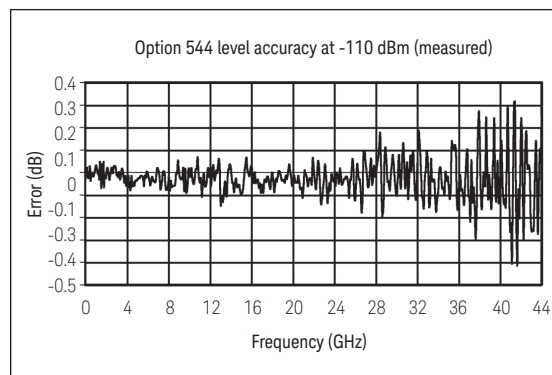
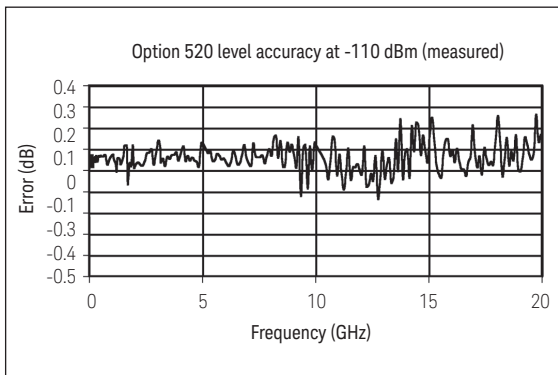

Level accuracy (measured)

1. The step attenuator provides coarse power attenuation to achieve low power levels. Fine power level adjustment is provided by the ALC (automatic level control) within the attenuator hold range.
2. To within 0.1 dB of final amplitude within one attenuator range.
3. To within 0.5 dB of final amplitude within one attenuator range. Add up to 50 ms when using power search.
4. Specifications apply in CW and list/step sweep modes over the 15 to 35 °C temperature range, with attenuator hold off (normal operating mode). Degradation outside this range, for ALC power levels > -5 dBm and frequency > 10 MHz, is typically < 0.3 dB. In ramp sweep mode (with Option 007), specifications are typical. For instruments with type-N connectors (Option 1ED), specifications apply only up to 18 GHz and typical level accuracy degrades by 0.2 dB above 18 GHz. Specifications do not apply above the maximum specified power.
5. For Options 513 and 520, measured with symbol rate > 10 kHz and power ≤ -1 dBm. For Options 532 and 544, measured with symbol rate > 10 kHz and power ≤ -3 dBm.
6. Relative to ALC on, after power search is executed. When applying external I/Q signals with ALC off, output level will vary directly with I/Q input level.

Resolution	0.01 dB
Temperature stability	0.01 dB/ °C (typ) ¹
User flatness correction	
Number of points	2 to 1601 points/table
Number of tables	Up to 10,000, memory limited
Path loss	Arbitrary, within attenuator range
Entry modes	Remote power meter ² , remote bus, manual (user edit/view)
Output impedance	50 Ω (nom)
SWR (internally leveled)	
Options 513 and 520	
250 kHz to 2 GHz	< 1.4:1 (typ)
> 2 GHz to 20 GHz	< 1.6:1 (typ)
Options 532 and 544	
250 kHz to 1.2 GHz	< 1.4:1 (typ)
> 1.2 GHz to 20 GHz	< 1.6:1 (typ)
> 20 GHz	< 1.8:1 (typ)
Leveling modes	Internal leveling, external detector leveling, millimeter source module, ALC off
External detector leveling	
Range	-0.2 mV to -0.5 V (nom) (-36 dBm to +4 dBm using Keysight 33330D/E detector)
Bandwidth	Selectable 0.1 to 100 kHz (nom) (note: not intended for pulsed operation)
Maximum reverse power	1/2 Watt, 0 V _{DC}
Adjustable RF output limit	
Function	Protects external devices by limiting maximum RF output; operates in all leveling modes (internal, external, source module)
Range	User-adjustable from +15 dBm to maximum output power
Accuracy	
+15 to +25 dBm	± 1 dB (typ)
> +25 dBm	± 1.5 dB (typ)
Resolution	1 dB
Response time	30 μsec (measured)
Adjustment	Can be locked to prevent accidental change

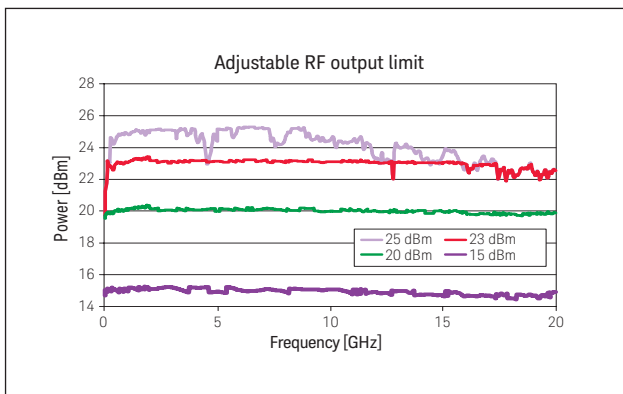

RF output limit (measured)

- Options 532 and 544: 0.02 dB/°C (typ) above 2 GHz.
- Compatible with Keysight EPM/EPM-P Series power meters.

Spectral purity

Harmonics ¹ (dBc at +10 dBm or maximum specified output power, whichever is lower)

Frequency	Standard
< 1 MHz	-25 dBc (typ)
1 to < 10 MHz	-25 dBc
10 to < 60 MHz	-28 dBc
10 to < 60 MHz with Option 1EH filters on ²	-45 dBc
0.06 to 2 GHz	-30 dBc
0.06 to 2 GHz with Option 1EH filters on ²	-55 dBc
> 2 to 20 GHz	-55 dBc
> 20 to 44 GHz	-45 dBc (typ)

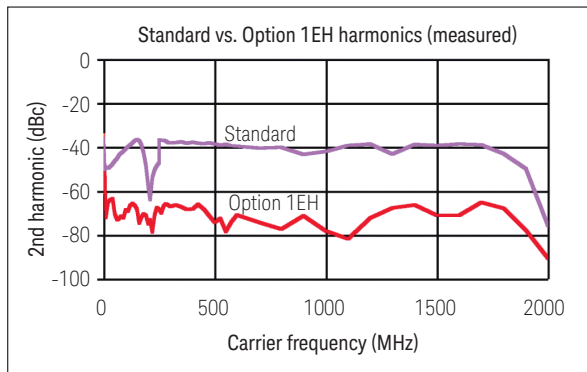
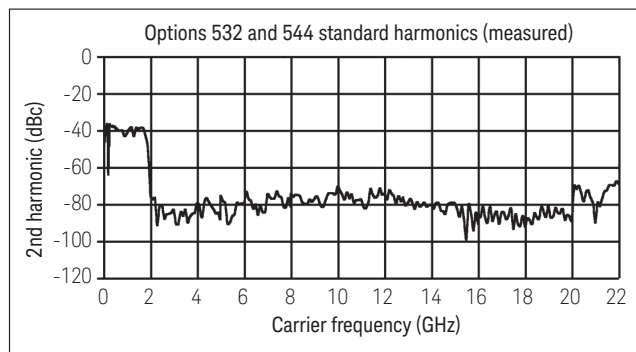
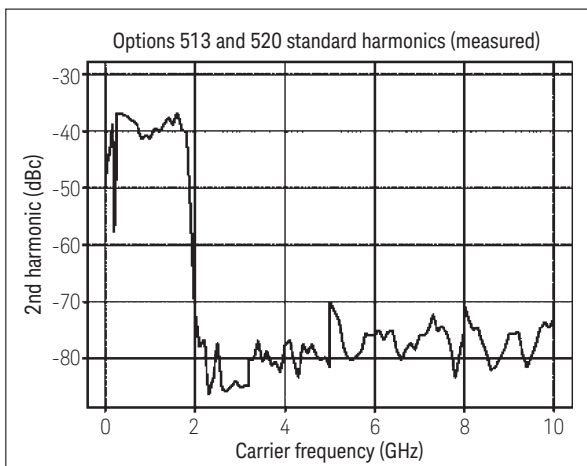

Harmonics (measured)

1. Specifications are typical for harmonics beyond specified frequency. Specifications are with Option 1EH low-pass filters below 2 GHz off, unless noted.
2. Below 250 MHz in ramp sweep mode (Option 007), Option 1EH filters are always off. Refer to harmonic specification with filters off.

Sub-harmonics ¹ (At +10 dBm or maximum specified output power, whichever is lower)

250 kHz to 10 GHz	None
> 10 GHz to 20 GHz	< -60 dBc
> 20 GHz to 44 GHz	< -45 dBc

Non-harmonics ^{2,3} (dBc at +10 dBm or maximum specified output power, whichever is lower)

Frequency	Offsets > 3 kHz (Standard) Spec (typ)	Offsets > 300 Hz (Opt UNX or UNY) Spec (typ)	Offsets > 3 kHz (Option UNY) Spec	Line-related (≤ 300 Hz) (typ)
250 kHz to 250 MHz	-58 (-62) ⁴	-58 (-62) ⁴	-58	(-55)
> 250 MHz to 1 GHz	-80 (-88)	-80 (-88)	-80	(-55)
> 1 to 2 GHz	-74 (-82)	-74 (-82)	-80	(-55)
> 2 to 3.2 GHz	-68 (-76)	-68 (-76)	-76	(-55)
> 3.2 to 10 GHz	-62 (-70)	-62 (-70)	-70	(-50)
> 10 to 20 GHz	-56 (-64)	-56 (-64)	-64	(-45)
> 20 to 28.5 GHz	-52 (-60)	-52 (-60)	-58	(-39)
> 28.5 to 44 GHz	-48 (-56)	-48 (-56)	-52	(-37)

Residual FM (RMS, 50 Hz to 15 kHz bandwidth)

CW mode	< N x 8 Hz (typ)
CW mode with Option UNX or UNY	< N x 4 Hz (typ)
Ramp sweep mode	< N x 1 kHz (typ)

Broadband noise (CW mode at +10 dBm or maximum specified output power, whichever is lower, for offsets > 10 MHz)

> 2.4 to 20 GHz	< -148 dBc/Hz (typ)
> 20 GHz	< -141 dBc/Hz (typ)

Measured RMS jitter: ⁵

Standard carrier frequency	SONET/SDH data rates	RMS jitter bandwidth	Unit intervals (μUI)	Time (fs)
155 MHz	155 MB/s	100 Hz to 1.5 MHz	25	158
622 MHz	622 MB/s	1 kHz to 5 MHz	21	34
2.488 GHz	2488 MB/s	5 kHz to 20 MHz	57	23
9.953 GHz	9953 MB/s	10 kHz to 80 MHz	152	15
39.812 GHz	39812 MB/s	40 kHz to 320 MHz	627	16

1. Sub-harmonics are defined as carrier freq * (x/y), where x and y are integers, and x is not an integer multiple of y. Specifications are typical for sub-harmonics beyond specified frequency range. Specifications are typical when I/Q modulation is on.
2. Performance is typical for spurs at frequencies above the maximum operating frequency of the instrument. Specifications apply for CW mode, without modulation. In ramp sweep mode (Option 007), performance is typical for offsets > 1 MHz.
3. Excluding external mechanical vibration.
4. For offsets > 10 kHz.
5. Calculated from phase noise performance in CW mode only at +10 dBm. For other frequencies, data rates, or bandwidths, please contact your sales representative.

Option UNX carrier frequency	SONET/SDH data rates	RMS jitter bandwidth	Unit intervals (μ UI)	Time (fs)
155 MHz	155 MB/s	100 Hz to 1.5 MHz	23	151
622 MHz	622 MB/s	1 kHz to 5 MHz	19	30
2.488 GHz	2488 MB/s	5 kHz to 20 MHz	56	22
9.953 GHz	9953 MB/s	10 kHz to 80 MHz	152	15
39.812 GHz	39812 MB/s	40 kHz to 320 MHz	626	16
Option UNY carrier frequency	SONET/SDH data rates	RMS jitter bandwidth	Unit intervals (μ UI)	Time (fs)
155 MHz	155 MB/s	100 Hz to 1.5 MHz	21	130
622 MHz	622 MB/s	1 kHz to 5 MHz	22	35
2.488 GHz	2488 MB/s	5 kHz to 20 MHz	53	21
9.953 GHz	9953 MB/s	10 kHz to 80 MHz	96	10
39.812 GHz	39812 MB/s	40 kHz to 320 MHz	518	13
SSB phase noise (dBc/Hz) (CW) ¹		20 kHz offset from carrier		
Frequency	Spec	Typical		
250 kHz to 250 MHz	-130	-134		
> 250 to 500 MHz	-134	-138		
> 500 MHz to 1 GHz	-130	-134		
> 1 to 2 GHz	-124	-128		
> 2 to 3.2 GHz	-120	-124		
> 3.2 to 10 GHz	-110	-113		
> 10 to 20 GHz	-104	-108		
> 20 to 28.5 GHz	-100	-104		
> 28.5 GHz	-96	-100		

1. Phase noise specifications are warranted from 15 to 35 °C excluding external mechanical vibration. Measured at +10 dBm or maximum specified output power, whichever is less.

Option UNX: absolute SSB phase noise (dBc/Hz) (CW) ^{1, 2}			Offset from carrier			
Frequency	1 Hz spec (typ)	10 Hz spec (typ)	100 Hz spec (typ)	1 kHz spec (typ)	10 kHz spec (typ)	100 kHz spec (typ)
250 kHz to 250 MHz	-58 (-66)	-87 (-94)	-104 (-120)	-121 (-128)	-128 (-132)	-130 (-133)
> 250 to 500 MHz	-61 (-72)	-88 (-98)	-108 (-118)	-125 (-132)	-132 (-136)	-136 (-141)
> 500 MHz to 1 GHz	-57 (-65)	-84 (-93)	-101 (-111)	-121 (-130)	-130 (-134)	-130 (-135)
> 1 to 2 GHz	-51 (-58)	-79 (-86)	-96 (-106)	-115 (-124)	-124 (-129)	-124 (-129)
> 2 to 3.2 GHz	-46 (-54)	-74 (-82)	-92 (-102)	-111 (-120)	-120 (-124)	-120 (-124)
> 3.2 to 10 GHz	-37 (-44)	-65 (-72)	-81 (-92)	-101 (-109)	-110 (-114)	-110 (-115)
> 10 to 20 GHz	-31 (-38)	-59 (-66)	-75 (-87)	-95 (-106)	-104 (-107)	-104 (-109)
> 20 to 28.5 GHz	-25 (-34)	-56 (-62)	-72 (-83)	-92 (-102)	-100 (-103)	-100 (-105)
> 28.5 to 44 GHz	-20 (-30)	-51 (-58)	-68 (-77)	-88 (-97)	-96 (-99)	-96 (-101)
Option UNY: absolute SSB phase noise (dBc/Hz) (CW) ^{1, 2}			Offset from carrier, optimized for less than 150 kHz (mode 1)			
Frequency	1 Hz spec (typ)	10 Hz spec (typ)	100 Hz spec (typ)	1 kHz spec (typ)	10 kHz spec (typ)	100 kHz spec (typ)
250 kHz to 250 MHz	-64 (-70)	-92 (-98)	-115 (-125)	-123 (-135)	-138 (-144)	-141 (-144)
> 250 to 500 MHz	-67 (-77)	-93 (-101)	-111 (-116)	-125 (-132)	-138 (-144)	-142 (-147)
> 500 MHz to 1 GHz	-62 (-69)	-91 (-99)	-105 (-111)	-121 (-128)	-138 (-143)	-138 (-144)
> 1 to 2 GHz	-57 (-63)	-86 (-90)	-100 (-106)	-115 (-121)	-133 (-138)	-133 (-139)
> 2 to 3.2 GHz	-52 (-58)	-81 (-84)	-96 (-102)	-111 (-117)	-128 (-134)	-128 (-134)
> 3.2 to 10 GHz	-43 (-49)	-72 (-76)	-85 (-91)	-101 (-107)	-120 (-126)	-120 (-125)
> 10 to 20 GHz	-37 (-43)	-66 (-70)	-79 (-85)	-95 (-101)	-114 (-121)	-114 (-119)
> 20 to 28.5 GHz	-31 (-37)	-60 (-66)	-73 (-79)	-89 (-95)	-108 (-113)	-108 (-113)
> 28.5 to 44 GHz	-26 (-32)	-54 (-60)	-68 (-73)	-84 (-90)	-102 (-107)	-102 (-107)
Option UNX: residual SSB phase noise (dBc/Hz) (CW) ^{1, 2}			Offset from carrier			
Frequency	1 Hz spec (typ)	10 Hz spec (typ)	100 Hz spec (typ)	1 kHz spec (typ)	10 kHz spec (typ)	100 kHz spec (typ)
250 kHz to 250 MHz	(-94)	-100 (-107)	-110 (-118)	-120 (-126)	-128 (-132)	-130 (-133)
> 250 to 500 MHz	(-101)	-105 (-112)	-115 (-122)	-124 (-131)	-132 (-136)	-136 (-141)
> 500 MHz to 1 GHz	(-94)	-100 (-107)	-110 (-118)	-120 (-126)	-130 (-134)	-130 (-134)
> 1 to 2 GHz	(-89)	-96 (-101)	-104 (-112)	-114 (-120)	-124 (-129)	-124 (-129)
> 2 to 3.2 GHz	(-85)	-92 (-97)	-100 (-108)	-110 (-116)	-120 (-124)	-120 (-124)
> 3.2 to 10 GHz	(-74)	(-87)	(-98)	(-106)	(-114)	(-115)
Option UNY: residual SSB phase noise (dBc/Hz) (CW) ^{1, 2}			Offset from carrier, optimized for less than 150 kHz (mode 1)			
Frequency	1 Hz spec (typ)	10 Hz spec (typ)	100 Hz spec (typ)	1 kHz spec (typ)	10 kHz spec (typ)	100 kHz spec (typ)
250 kHz to 250 MHz	(-94)	-100 (-107)	-110 (-118)	-123 (-135)	-138 (-144)	-141 (-144)
> 250 to 500 MHz	(-101)	-105 (-112)	-115 (-122)	-124 (-130)	-138 (-144)	-140 (-147)
> 500 MHz to 1 GHz	(-94)	-100 (-108)	-110 (-118)	-120 (-126)	-135 (-142)	-135 (-145)
> 1 to 2 GHz	(-89)	-96 (-101)	-104 (-112)	-115 (-121)	-133 (-138)	-133 (-139)
> 2 to 3.2 GHz	(-85)	-92 (-97)	-100 (-108)	-111 (-117)	-128 (-134)	-128 (-134)
> 3.2 to 10 GHz	(-74)	(-87)	(-98)	(-104)	(-126)	(-125)

1. Phase noise specifications are warranted from 15 to 35 °C. Excluding external mechanical vibration. Option UNY specifications at 1 kHz offset apply from 25 to 35 °C.
2. Measured at +10 dBm or maximum specified power, whichever is less.

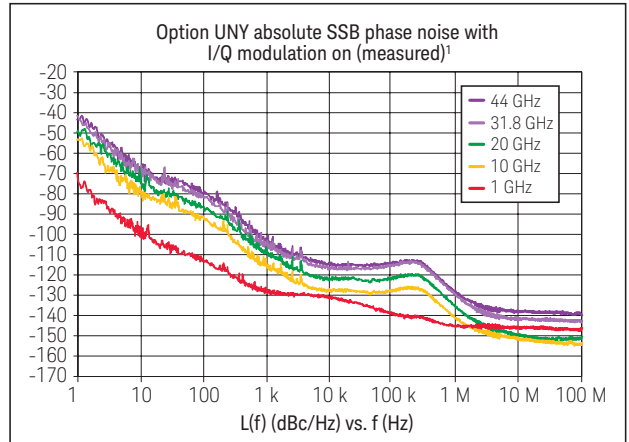
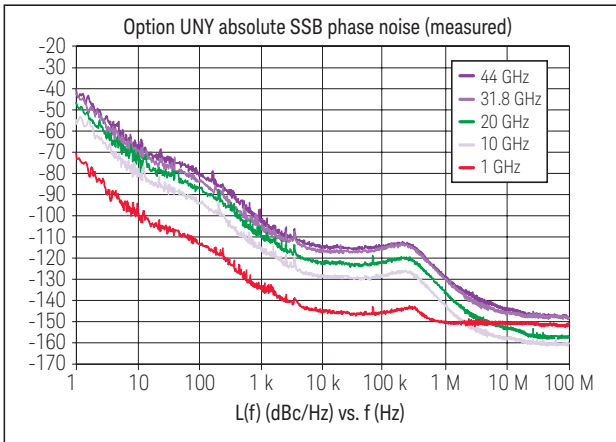
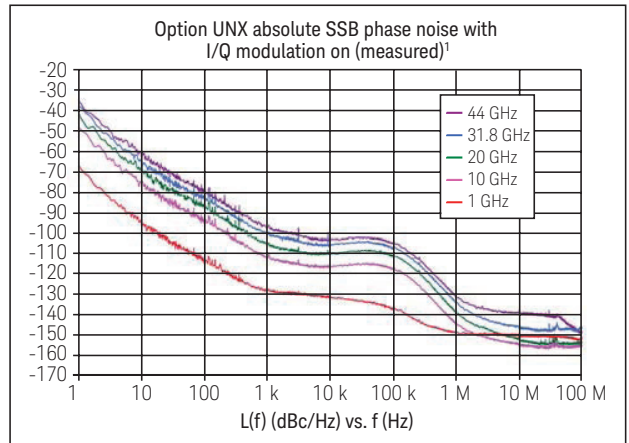
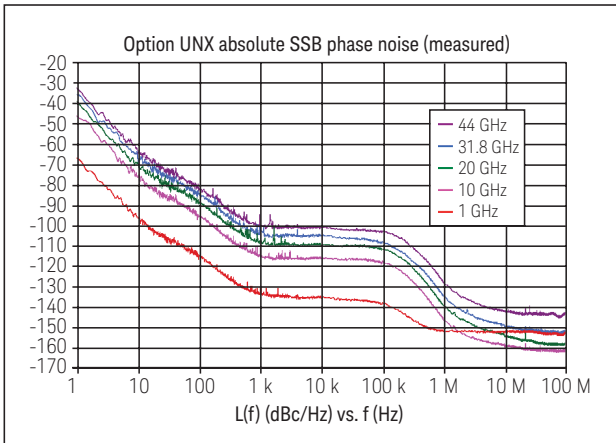
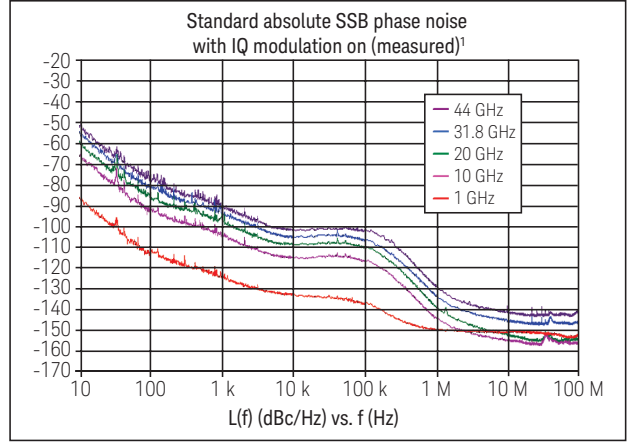
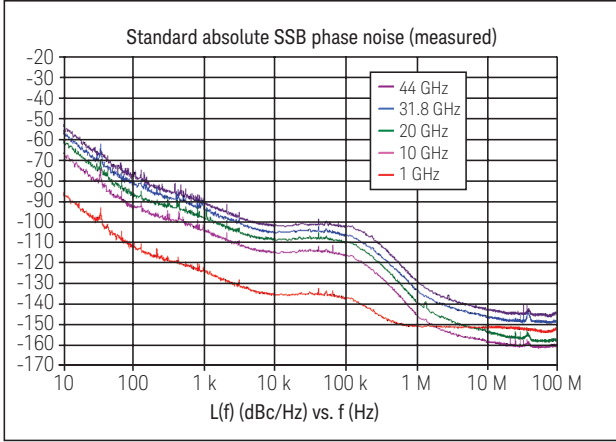

Measured phase noise (data collected with the E5500 and plotted without spurs)
 Option UNY phase noise optimized for offsets less than 150 kHz (mode 1)

1. I/Q modulator attenuator set to auto. External I/Q input level $\sqrt{(I^2 + Q^2)} = 0.5 V_{rms}$.

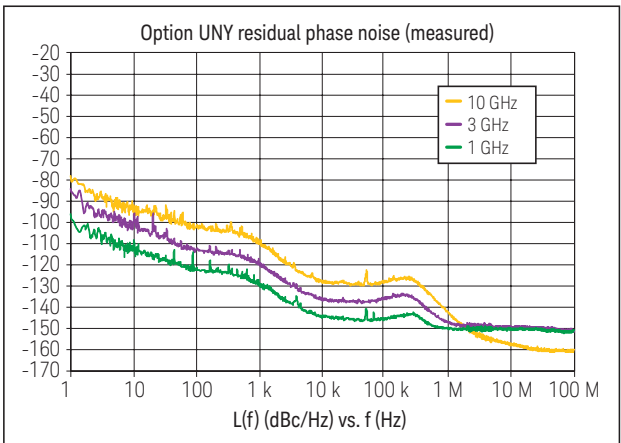
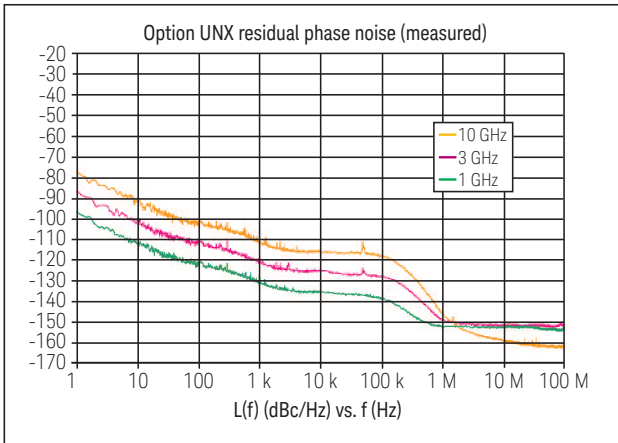
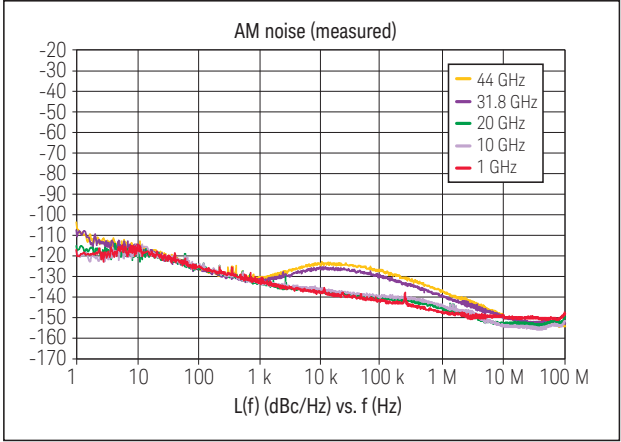
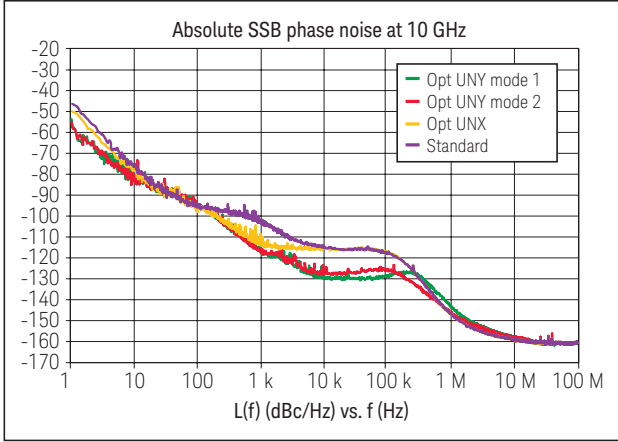

Measured phase noise (data collected with the E5500 and plotted without spurs)
 Option UNY phase noise optimized for offsets less than 150 kHz (mode 1)

Frequency modulation (Option UNT)		
Maximum deviation ¹ (normal mode)	Frequency	Max deviation
	250 kHz to 250 MHz	2 MHz
	> 250 to 500 MHz	1 MHz
	> 500 MHz to 1 GHz	2 MHz
	> 1 GHz to 2 GHz	4 MHz
	> 2 GHz to 3.2 GHz	8 MHz
	> 3.2 GHz to 10 GHz	16 MHz
	> 10 GHz to 20 GHz	32 MHz
	> 20 GHz to 28.5 GHz	48 MHz
	> 28.5 GHz to 44 GHz	80 MHz
Resolution	0.1% of deviation or 1 Hz, whichever is greater	
Deviation accuracy	< ± (3.5% of FM deviation + 20 Hz) (1 kHz rate, deviations < N x 800 kHz)	
Modulation frequency response ² (at 100 kHz deviation)		
Path [coupling]	1 dB bandwidth	3 dB bandwidth (typ)
Standard or Option UNX		
FM path 1 [DC]	DC to 100 kHz	DC to 10 MHz
FM path 2 [DC]	DC to 100 kHz	DC to 1 MHz
FM path 1 [AC]	20 Hz to 100 kHz	5 Hz to 10 MHz
FM path 2 [AC]	20 Hz to 100 kHz	5 Hz to 1 MHz
Option UNY		
FM path 1 [DC]	DC to 100 kHz	DC to 9.3 MHz
FM path 2 [DC]	DC to 100 kHz	DC to 1 MHz
FM path 1 [AC]	20 Hz to 100 kHz	5 Hz to 9.3 MHz
FM path 2 [AC]	20 Hz to 100 kHz	5 Hz to 1 MHz
DC FM ³ carrier offset	± 0.1% of set deviation + (N x 8 Hz)	
Distortion	< 1% (1 kHz rate, deviations < N x 800 kHz)	
Sensitivity	± 1 V _{peak} for indicated deviation	
Paths	FM1 and FM2 are summed internally for composite modulation. Either path may be switched to any one of the modulation sources: Ext1, Ext2, internal1, internal2. The FM2 path is limited to a maximum rate of 1 MHz. The FM2 path must be set to a deviation less than FM1. To avoid distortion and clipping, signals applied with any combination of FM1, FM2, or FM1+FM2 should not exceed 1 V _{peak} .	

1. Through any combination of path1, path2, or path1 + path2.
2. Specifications apply in CW and list/step sweep modes. During ramp sweep operation (Option 007), 3 dB bandwidth is typically 50 kHz to 10 MHz (FM1 path), and 50 kHz to 1 MHz (FM2 path).
3. At the calibrated deviation and carrier frequency, within 5 °C of ambient temperature at time of user calibration.

Phase modulation (Option UNT)				
Maximum deviation ¹				
Standard or Option UNX	Frequency	100 kHz BW mode	1 MHz BW mode	
	250 kHz to 250 MHz	20 rad	2 rad	
	> 250 to 500 MHz	10 rad	1 rad	
	> 500 MHz to 1 GHz	20 rad	2 rad	
	> 1 GHz to 2 GHz	40 rad	4 rad	
	> 2 GHz to 3.2 GHz	80 rad	8 rad	
	> 3.2 GHz to 10 GHz	160 rad	16 rad	
	> 10 GHz to 20 GHz	320 rad	32 rad	
	> 20 GHz to 28.5 GHz	480 rad	48 rad	
> 28.5 GHz to 44 GHz	800 rad	80 rad		
Option UNY	Frequency	1 MHz BW mode	10 MHz BW mode	
	250 kHz to 250 MHz	2 rad	0.2 rad	
	> 250 to 500 MHz	1 rad	0.1 rad	
	> 500 MHz to 1 GHz	2 rad	0.2 rad	
	> 1 GHz to 2 GHz	4 rad	0.4 rad	
	> 2 GHz to 3.2 GHz	8 rad	0.8 rad	
	> 3.2 GHz to 10 GHz	16 rad	1.6 rad	
	> 10 GHz to 20 GHz	32 rad	3.2 rad	
	> 20 GHz to 28.5 GHz	48 rad	4.8 rad	
> 28.5 GHz to 44 GHz	80 rad	8.0 rad		
Resolution	0.1% of set deviation			
Deviation accuracy	< ± 5% of deviation + 0.01 radians (1 kHz rate, with 1 MHz BW mode for Option UNY or 100 kHz BW mode otherwise)			
Modulation frequency response ²	Rates (3 dB bandwidth)	Standard	UNX	UNY
100 kHz BW mode	DC to 100 kHz	Normal	Normal	n/a
1 MHz BW mode	DC to 1 MHz (typ) ³	High	High	Normal
10 MHz BW mode	DC to 10 MHz (typ)	n/a	n/a	High
Distortion				
Standard or Option UNX	< 1% (1 kHz rate, total harmonic distortion (THD), deviation < N x 80 rad, 100 kHz BW mode)			
Option UNY	< 1% (1 kHz rate, total harmonic distortion (THD), deviation < N x 8 rad, 1 MHz BW mode)			
Sensitivity	± 1 V _{peak} for indicated deviation			
Paths	□M1 and □M2 are summed internally for composite modulation; either path may be switched to any one of the modulation sources: ext1, ext2, internal1, internal2; the □M2 path is limited to a maximum rate of 1 MHz, the □M2 path must be set to a deviation less than □M1; to avoid distortion and clipping, signals applied with any combination of □M1, □M2, or □M1+ □M2 should not exceed 1 V _{peak} .			

1. Through any combination of path1, path2, or path1 + path2.

2. Specifications apply in CW and list/step sweep modes. During ramp sweep operation (Option 007), 3 dB bandwidth is typically 50 kHz to 1 MHz (high BW mode).

3. Path 1 is useable to 4 MHz for external inputs less than 0.3 V_{peak}.

Amplitude modulation ¹ (Option UNT) (typical)		
Depth	Linear mode	Exponential (log) mode (downward modulation only)
Maximum		
ALC on	> 90%	> 20 dB
ALC off with power search ² or ALC on with deep AM ³	> 95%	> 40 dB
Settable	0 to 100%	0 to 40 dB
Sensitivity	0 to 100%/V	0 to 40 dB/V
Resolution	0.1%	0.01 dB
Accuracy (1 kHz rate)	< ± (6% of setting + 1%)	< ± (2% of setting + 0.2 dB)
External input (selectable polarity)		
Sensitivity for indicated depth	1 V _{peak}	-1 V or +1 V
Maximum allowable	± 1 V	± 3.5 V
Rates (3 dB bandwidth, 30% depth)		
DC coupled	0 to 100 kHz	
AC coupled	10 Hz to 100 kHz (useable to 1 MHz)	
Distortion (1 kHz rate, linear mode, total harmonic distortion (THD))		
30% AM	< 1.5%	
60% AM	< 2%	
Paths	AM1 and AM2 are summed internally for composite modulation. Either path may be switched to any one of the modulation sources: ext1, ext2, internal1, internal2	

External modulation inputs (Ext1 & Ext2) (Option UNT)	
Modulation types	AM, FM, and ◻M
Input impedance	50 or 600 Ω (nom), switched
High/low indicator	100 Hz to 10 MHz BW, activated when input level error exceeds 3% (nom), ac coupled inputs only

Internal modulation source (Option UNT)	
Dual function generators	Provide two independent signals (internal1 and internal2) for use with AM, FM, ◻M, or LF out
Waveforms	Sine, square, positive ramp, negative ramp, triangle, Gaussian noise, uniform noise, swept sine, dual sine ⁴
Rate range	
Sine	0.5 Hz to 1 MHz
Square, ramp, triangle	0.5 Hz to 100 kHz
Resolution	0.5 Hz
Accuracy	Same as timebase
LF out	
Output	Internal1 or internal2; also provides monitoring of internal1 or internal2 when used for AM, FM, or ◻M
Amplitude	0 to 3 V _{peak} (nom) into 50 Ω
Output impedance	50 Ω (nom)
Swept sine mode	(frequency, phase continuous)
Operating modes	Triggered or continuous sweeps
Frequency range	1 Hz to 1 MHz
Sweep rate	0.5 to 100,000 sweeps/s, equivalent to sweep times 10 μs to 2 s
Resolution	0.5 Hz (0.5 sweep/s)

1. AM specifications are typical. For carrier frequencies below 2 MHz, AM is useable but not specified. Unless otherwise stated, specifications apply with ALC on, deep AM off, and envelope peaks within ALC operating range (-15 dBm to maximum specified power, excluding step attenuator setting).
2. ALC off is used for narrow pulse modulation and/or high AM depths, with envelope peaks below ALC operating range. Carrier power level will be accurate after a power search is executed.
3. ALC on with deep AM provides high AM depths together with closed-loop internal leveling. This mode must be used with a repetitive AM waveform (frequency > 10 Hz) with peaks > -5 dBm (nominal, excluding step-attenuator setting).
4. Internal2 is not available when using swept sine or dual sine modes.

Wideband AM		
Rate (typical 1 dB bandwidth)		
ALC on	1 kHz to 80 MHz	
ALC off	DC to 80 MHz	
External I input		
Sensitivity	0.5 V = 100%	
Input impedance	50 Ω (nom)	
Pulse modulation ¹ (Option UNU or UNW)		
On/off ratio	Option UNU	Option UNW
	80 dB (typical)	80 dB
Rise/fall times (Tr, Tf)		
50 to 400 MHz	10 ns (typical)	15 ns (10 ns typical)
> 400 MHz	6 ns (typical)	10 ns (6 ns typical)
Minimum pulse width		
ALC on	1 μ s	1 μ s
ALC off		
50 to 400 MHz	150 ns	30 ns
> 400 MHz	150 ns	20 ns
Repetition frequency		
ALC on	10 Hz to 500 kHz	10 Hz to 500 kHz
ALC off	dc to 3 MHz	dc to 10 MHz
Level accuracy (relative to CW)		
ALC on ²	\pm 0.5 dB (0.15 dB typical)	\pm 0.5 dB (0.15 dB typical)
ALC off with power search ³		
50 MHz to 3.2 GHz	\pm 0.7 dB (typical)	\pm 0.7 dB (typical)
> 3.2 GHz	\pm 0.5 dB (typical)	\pm 0.5 dB (typical)
Width compression (RF width relative to video out)		
	\pm 5 ns (typical)	\pm 5 ns (typical)
Video feed-through ⁴		
50 to 250 MHz	< 3% (typical)	< 3% (typical)
> 250 to 400 MHz	< 11% (typical)	< 11% (typical)
> 0.4 to 3.2 GHz	< 6% (typical)	< 6% (typical)
> 3.2 GHz	< 2 mV pk-pk (typ)	< 2 mV pk-pk (typ)
Video delay (ext input to video)		
	50 ns (nom)	50 ns (nom)

1. With ALC off, specs apply after the execution of power search. Specifications apply with Atten Hold Off (default mode for instruments with attenuator), or ALC level between -5 and $+10$ dBm or maximum specified power, whichever is lower. Below 50 MHz, pulse modulation is useable; however performance is not warranted.
2. \pm 0.8 dB for pulse width ≤ 1 μ s with RF frequency ≤ 100 MHz
3. Power search is a calibration routine that improves level accuracy with ALC off. The instrument microprocessor momentarily closes the ALC loop to find the modulator drive setting necessary to make the quiescent RF level equal to an entered value, then opens the ALC loop while maintaining that modulator drive setting. When executing power search, RF power will be present for typically 10 to 50 ms; the step attenuator can be set to automatically switch to maximum attenuation to protect sensitive devices. Power search can be configured to operate either automatically or manually at the carrier frequency, or over a user-definable frequency range. Power search may not operate above the maximum specified output power.
4. With step attenuator in 0 dB position. Above 3.2 GHz, video feed-through decreases with step attenuator setting. Below 3.2 GHz, video feed-through is expressed as a percentage of RF output level.

RF delay (video to RF output)	Option UNU	Option UNW
50 to 250 MHz	35 ns (nominal)	35 ns (nominal)
> 0.25 to 3.2 GHz	25 ns (nominal)	25 ns (nominal)
> 3.2 GHz	30 ns (nominal)	30 ns (nominal)
Pulse overshoot	< 10% (typ)	< 10% (typ)
Input level	+1 V = RF on	+1 V = RF on
Input impedance	50 Ω (nom)	50 Ω (nom)

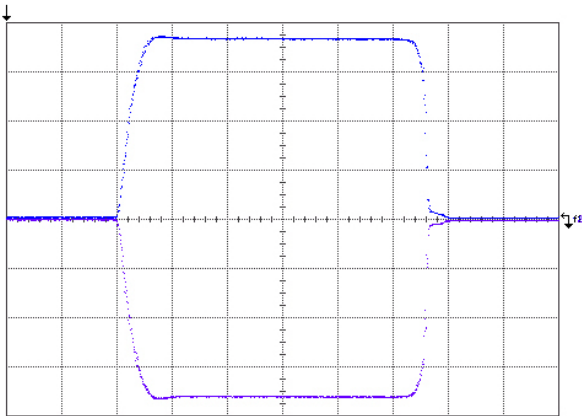

Measured pulse modulation envelope
Frequency = 9 GHz, amplitude = 10 dBm, ALC off, 10 ns/div

Internal pulse generator (Option UNU or UNW)

Modes	Free-run, triggered, triggered with delay, doublet, and gated. Triggered with delay, doublet, and gated require external trigger source.
Period (PRI) (T_p)	70 ns to 42 s (repetition frequency: 0.024 Hz to 14.28 MHz)
Pulse width (T_w)	10 ns to 42 s
Delay (T_d)	
Free-run mode	0 to ± 42 s
Triggered with delay and doublet modes	75 ns to 42 s with ± 10 ns jitter
Resolution	10 ns (width, delay, and PRI)

- T_d video delay (variable)
- T_w video pulse width (variable)
- T_p Pulse period (variable)
- T_m RF delay
- T_{rf} RF pulse width
- T_f RF pulse fall time
- T_r RF pulse rise time
- V_{or} pulse overshoot
- V_f video feedthrough

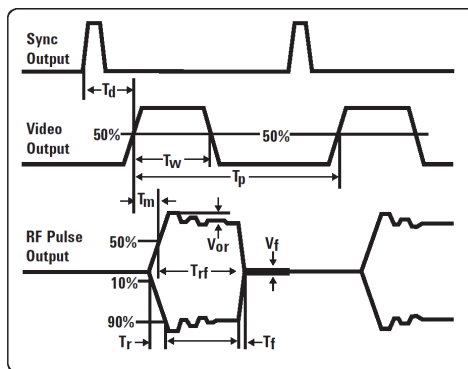

Simultaneous modulation

All modulation types (FM, AM, \square M, pulse and I/Q) may be simultaneously enabled except: FM with \square M, linear AM with exponential AM, and wideband AM with I/Q. AM, FM, and \square M can sum simultaneous inputs from any two sources (Ext1, ext2, internal1, or internal2). Any given source (Ext1, ext2, internal1, or internal2) may be routed to only one activated modulation type.

Vector modulation ¹ (Standard I/Q inputs)

External I/Q inputs

Input impedance switched	50 or 600 Ω (nom)
Input range ²	Minimum 0.1 V _{rms} , maximum 1 V _{peak}
Flatness	± 1 dB within ± 40 MHz of carrier (with ALC off) (typ)

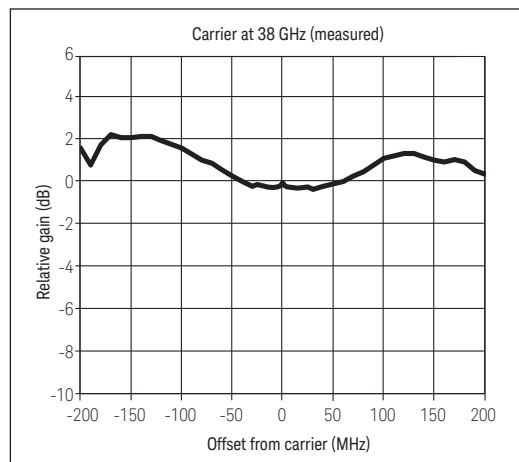
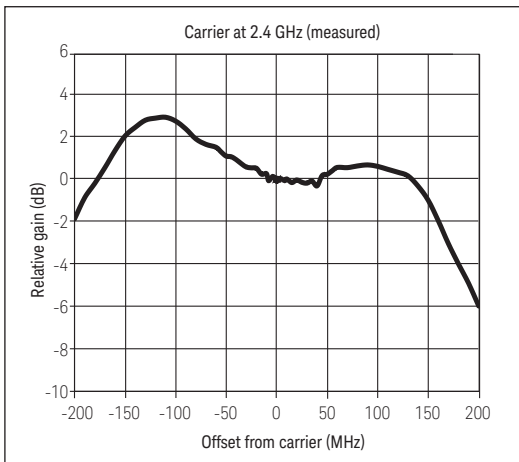
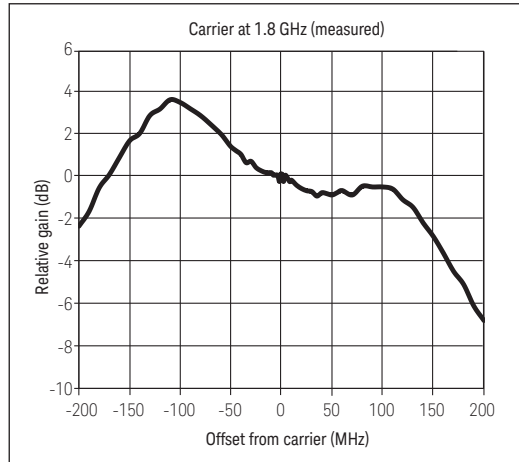
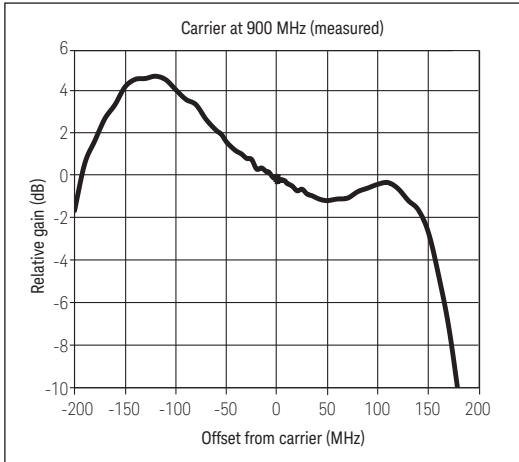

I/Q frequency response (measured) ³

RF path filters	Carrier frequency	Nominal filter cutoff
	≤ 250 MHz	300 MHz low-pass filter
	> 250 to 396 MHz	220 to 420 MHz bandpass filter
	> 396 to 628 MHz	350 to 650 MHz bandpass filter
	> 628 to 1000 MHz	1040 MHz low-pass filter
	> 1.0 to 1.5 GHz	1.6 GHz low-pass filter

1. With Option 007, vector modulation is not useable in ramp sweep mode. With Option 1EH, specifications apply with filters off.
2. Different RMS levels are accommodated by adjusting the internal I/Q modulator attenuator, which may be either manually or automatically set. The minimum input level required to maintain RF level accuracy is $\sqrt{I^2 + Q^2} = 0.1 V_{rms}$.
3. Sine wave response, measured with input level = 0.5 V_{rms} on one channel, and ALC off. For carrier frequencies at or below 1.5 GHz, modulation frequency response within ± 150 MHz of carrier may be limited by RF chain filtering.

I/Q adjustments		
I & Q offsets	External inputs (600 Ω): ± 5 Volts External inputs (50 Ω): $\pm 50\%$ Internal baseband generator: $\pm 50\%$	
I/Q attenuation	0 to 40 dB	
I/Q gain balance	± 4 dB	
I/Q quadrature skew	$\pm 10^\circ$ range (typ)	
Low pass filter	Selectable 40 MHz or through path	
I/Q baseband outputs		
Differential	I, I, \bar{Q} , \bar{Q}	
Single ended	I, Q	
Frequency range	DC to 40 MHz	
Output voltage into 50 Ω	1.5 V _{peak-to-peak} (typ)	
DC offset adjustments	± 3 V	
DC offset resolution	1 mV	
Low pass filter	Selectable 40 MHz or through path	
Wideband external differential I/Q inputs ¹ (Option 016)		
Input	250 kHz to 3.2 GHz	3.2 to 44 GHz
Input (baseband) frequency range	DC to 130 MHz (nom)	DC to 1.0 GHz ²
Input impedance	50 Ω (nom)	50 Ω (nom)
Recommended input level	-1 dBm	0 dBm (nom)
Maximum input voltage	± 1 V _{DC}	± 1 V _{DC}
I/Q offset adjustments	$\pm 50\%$	$\pm 50\%$
I/Q quadrature skew	± 10 degrees	± 10 degrees (nom)

1. With Option 007, vector IQ modulation is not useable in ramp sweep mode.

2. Modulation frequency response within ± 1 GHz of the carrier frequency may be limited by the RF chain cutoff frequencies.

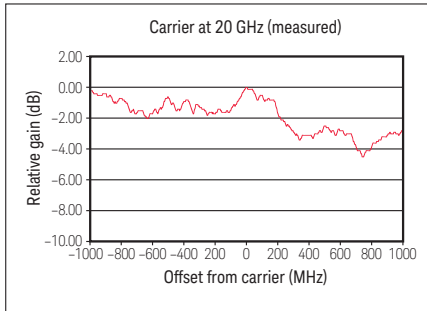
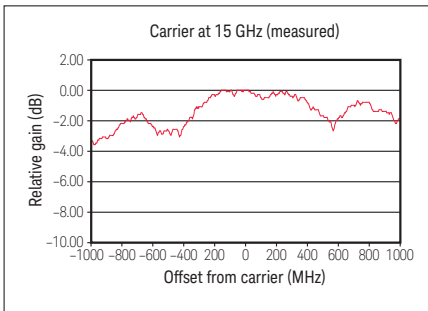
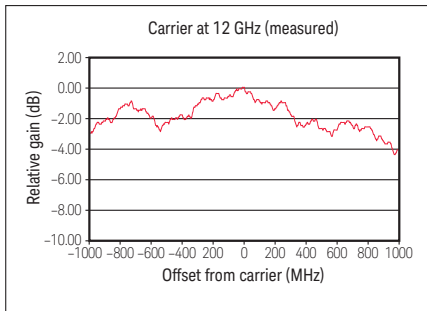
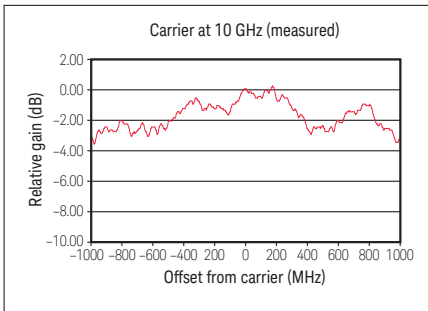
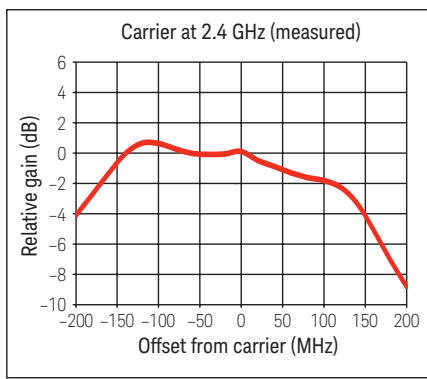
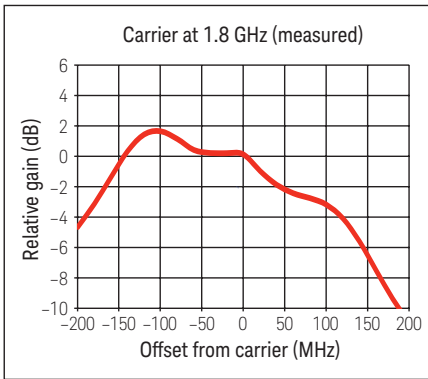
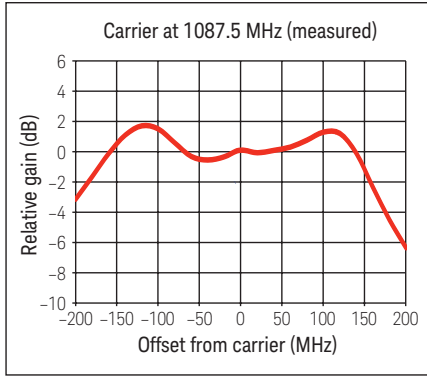
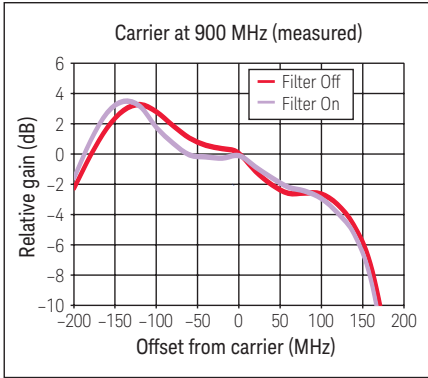

I/Q frequency response (measured) ¹

1. Sine wave response, measured with input level = $0.2 V_{rms}$ on one channel, and ALC off. Modulation frequency response may be limited by RF chain filtering. For operation near a filter edge, filters can be bypassed using software commands to increase modulation bandwidth.

RF path filters ¹	
Carrier frequency	Nominal filter cutoff frequencies
> 3.2 to 5 GHz	5.5 GHz low-pass filter
> 5 to 8 GHz	8.9 GHz low-pass filter
> 8 to 12.8 GHz	13.9 GHz low-pass filter
> 12.8 to 20 GHz	22.5 GHz low-pass filter
> 20 to 24 GHz	19.6 to 24.5 GHz bandpass filter
> 24 to 28.5 GHz	23.5 to 29.0 GHz bandpass filter
> 28.5 to 32 GHz	28.0 to 32.5 GHz bandpass filter
> 32 to 36 GHz	31.7 to 36.5 GHz bandpass filter
> 36 to 40 GHz	35.5 to 40.4 GHz bandpass filter
> 40 to 44 GHz	39.5 to 44.3 GHz bandpass filter

Internal baseband generator, arbitrary waveform mode (Option 602)	
Channels	2 [I and Q]
Resolution	16 bits [1/65,536]
Baseband waveform memory	
Length (playback)	64 megasamples (MSa/channel)
Length (non-volatile storage)	1.2 gigasamples (GSa) on 8 GB removable flash memory (Option 009)
Waveform segments	
Segment length	60 samples to 64 MSa
Maximum number of segments	8,192
Minimum memory allocation	256 samples or 1 kbyte blocks
Waveform sequences	
Sequencing	Continuously repeating
Maximum number of sequences	16,384
Maximum segments/sequence	32,768
Maximum segment repetitions	65,536

1. Modulation frequency response within ± 1 GHz of the carrier frequency may be limited by the RF chain cutoff frequencies. For operation near a filter edge, filters can be bypassed using software commands to increase modulation bandwidth.

Clock	
Sample rate	1 Hz to 100 MHz
Resolution	0.001 Hz
Accuracy	Same as timebase $+2^{-42}$ [in non-integer applications]
Reconstruction filter: [fixed]	50 MHz [used for all symbol rates]
Baseband spectral purity [full scale sine wave]	
Harmonic distortion	100 kHz to 2 MHz: < -65 dBc (typ)
Phase noise	< -127 dBc/Hz (typ) (baseband output of 10 MHz sine wave at 20 kHz offset)
IM performance	< -74 dB (typ)
Triggers	
Types	Continuous, single, gated, segment advance
Source	Trigger key, external, remote [LAN, GPIB, RS-232]
External polarity	Negative, positive
External delay time	10 ns to 40 s plus latency
External delay resolution	10 ns
Markers	Markers are defined in a segment during the waveform generation process or from the PSG front panel; a marker can also be tied to the RF blanking feature of the PSG
Marker polarity	Negative, positive
Number of markers	4
Multicarrier	
Number of carriers	Up to 100 (limited by a maximum bandwidth of 80 MHz depending on symbol rate and modulation type)
Frequency offset (per carrier)	-40 MHz to $+40$ MHz
Power offset (per carrier)	0 dB to -40 dB
Modulation	Types
PSK	BPSK, QPSK, OQPSK, $\pi/4$ DQPSK, 8PSK, 16PSK, D8PSK
QAM	4, 16, 32, 64, 128, 256
FSK	Selectable: 2, 4, 8, 16
MSK	Selectable phase deviation
Data	Random only

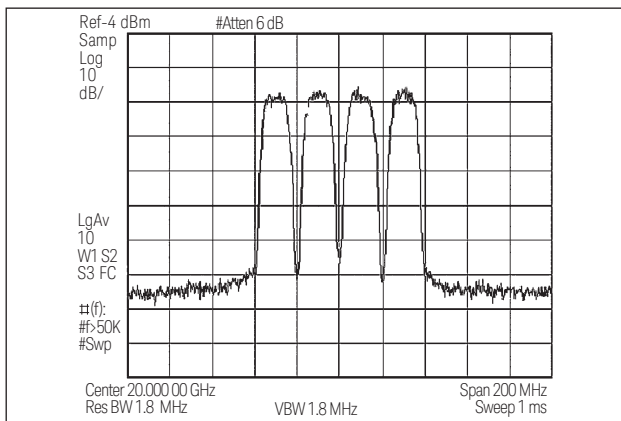

Four carriers with 64 QAM at 10 Msym/s with 20 MHz spacing (measured)

Multitone

Number of tones	2 to 64, with selectable on/off state per tone
Frequency spacing	100 Hz to 80 MHz
Phase (per tone)	Fixed or random
Power offset (per tone)	0 to -40 dB

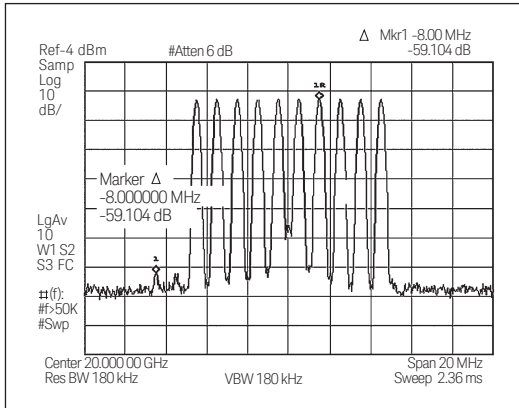

20 GHz multitone (measured)

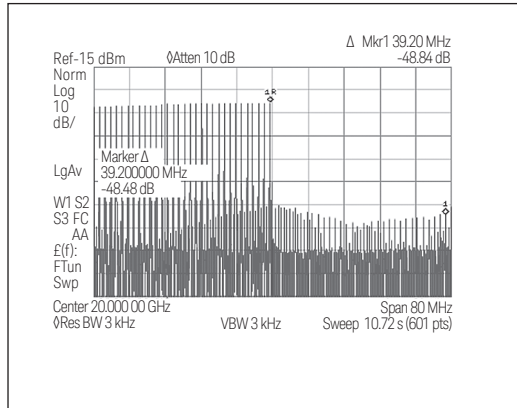

20 GHz image rejection (measured)

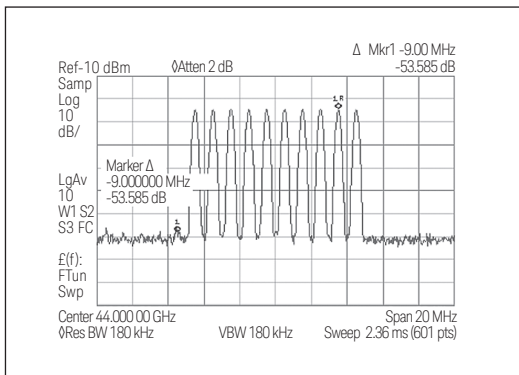

44 GHz multitone (measured)

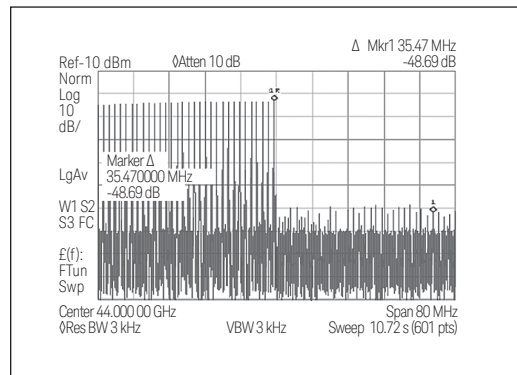

44 GHz image rejection (measured)

Two-tone

Frequency spacing	100 Hz to 80 MHz
Alignment	Left, centered, or right
IM distortion ¹	
250 kHz to 3.2 GHz	< -45 dBc (typ)
> 3.2 GHz to 20 GHz	< -55 dBc (typ) ²
> 20 to 40 GHz	< -50 dBc (typ)
> 40 to 44 GHz	< -45 dBc (typ)

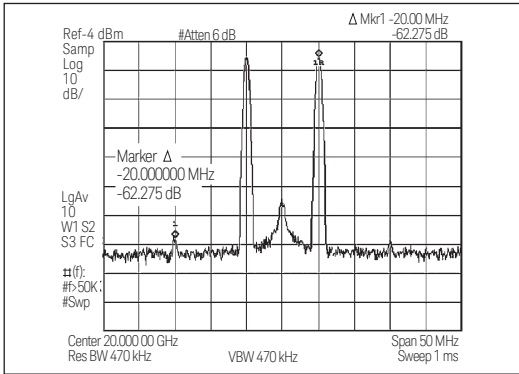

20 GHz two-tone (measured)

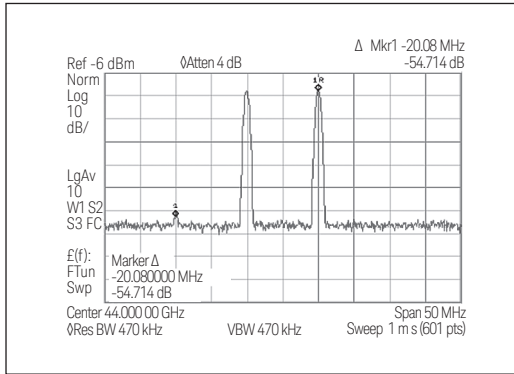

44 GHz two-tone (measured)

Internal baseband generator, real-time mode (Option 602)

Basic modulation types (custom format)

PSK	BPSK, QPSK, OQPSK, $\pi/4$ DQPSK, 8PSK, 16PSK, D8PSK	
MSK	User-defined phase offset from 0 to 100 °	
QAM	4, 16, 32, 64, 128, 256	
FSK	Selectable: 2, 4, 8, 16 level symmetric, C4FM	
	User defined: Up to 16 custom deviation levels	
	Deviation resolution: 0.1 Hz	
	Symbol rate	Maximum deviation
	< 5 MHz	4 times symbol rate
	5 MHz to 50 MHz	20 MHz

User-defined I/Q Custom map of 256 unique values

Vector accuracy ³ (Formats: BPSK, QPSK, 16-256 QAM [$\alpha = 0.3$, root Nyquist filter, symbol rate 4 Msym/s])

EVM (% RMS)	Spec	(typ)
≤ 20 GHz	< 1.2%	(< 0.8%)
> 20 to 32 GHz	< 1.3%	(< 0.9%)
> 32 to 44 GHz	< 1.4%	(< 0.9%)
Origin offset ⁴		(typ)
250 kHz to 3.2 GHz		(-45 dBc)
3.2 to 44 GHz		(-50 dBc)

- RF power ≤ -1 dBm (Option 513, 520) or ≤ -3 dBm (Option 532, 544). When external inputs are used, vector accuracy is equivalent to internal performance after system calibration.
- < -50 dBc (typ) for two tone frequency spacing of 80 MHz
- Valid after executing I/Q calibration when instrument is maintained within ± 5 °C of calibration temperature. RF power < 5 dBm (Option 513, 520) or < 3 dBm (Option 532, 544). When external inputs are used, vector accuracy is equivalent to internal performance, after system calibration.
- Valid after executing I/Q calibration when instrument is maintained at the calibration temperature.

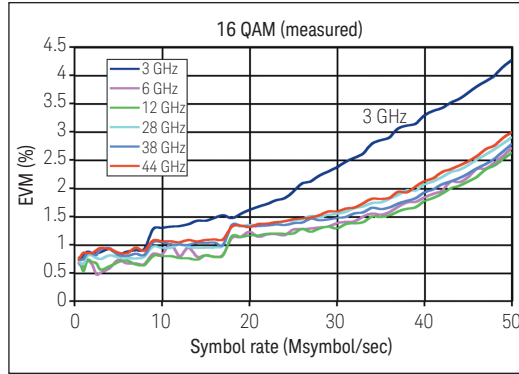
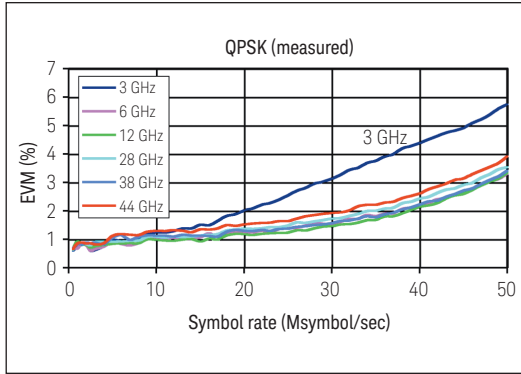

EVM (measured)

FIR filter

Selectable	Nyquist, root Nyquist, Gaussian, rectangular, α : 0 to 1, B_bT : 0.1 to 1
Custom FIR	16-bit resolution, up to 64 symbols long, automatically resampled to 1024 coefficients (maximum) For > 32 to 64 symbol filter: symbol rate \leq 12.5 MHz. For > 16 to 32 symbol filter: symbol rate \leq 25 MHz. Internal filters switch to 16 tap when symbol rate is between 25 and 50 MHz

Symbol rate

For external serial data	Adjustable from 1000 symbols/sec to a maximum symbol rate of 50 Mbits/sec \div (#bits/symbol)
For internally generated data	Adjustable from 1000 symbols/sec to 50 Msymbols/second and a maximum of 8 bits per symbol; modulation quality may be degraded at high symbol rates

Baseband reference frequency

Input	ECL, CMOS, TTL compatible, 50 Ω AC coupled
Use	Data clock can be phase locked to an external reference.

Frame trigger delay control

Range	0 to 1,048,575 bits
Resolution	1 bit

Data types

Internally generated data

Pseudo-random patterns	PN9, PN11, PN15, PN20, PN23
Repeating sequence	Any 4-bit sequence, other fixed patterns

Direct-pattern RAM [PRAM]

Max size	64 Mb (each bit uses an entire sample space)
Use	Non-standard framing
User file	
Max size	6.4 Mb
Use	Continuous modulation or internally generated TDMA standard

Externally generated data

Type	Serial data
Inputs	Data, data (bit) clock, symbol sync
Rate	Accepts data rates \pm 5% of specified data rate

Internal burst shape control

Rise/fall time range	Up to 30 bits, varies with standards and bit rates
Rise/fall delay range	0 to 63.5 bits, varies with standards and bit rates

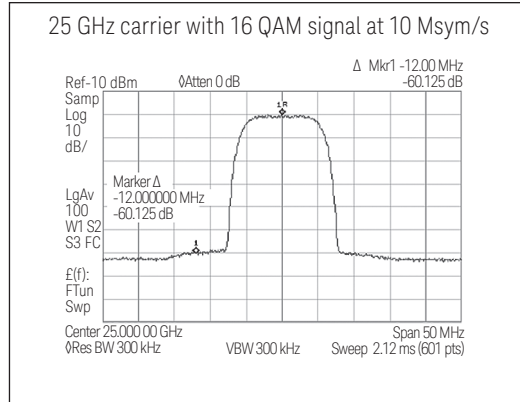
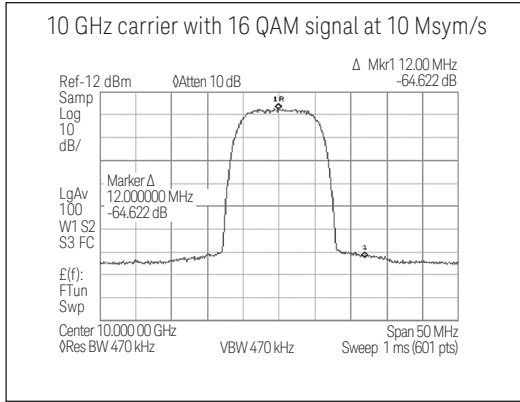

Spectral re-growth (measured)

Calibrated AWGN (Option 403)

Type	Real-time, continuously calculated, and played using DSP
Modes of operation	Standalone or digitally added to signal played by arbitrary waveform or real-time baseband generator
Noise bandwidth	Arbitrary waveform mode: 50 kHz to 15 MHz Real-time mode: 50 kHz to 80 MHz
Crest factor	16 dB
Randomness	Arbitrary waveform mode: 14, 15, 16, 17, 18, 19, or 20-bit pseudo-random waveform with fixed or random seed Repetition period: 0.4 ms to 2 s (dependent on noise BW and waveform length combination) Real-time mode: 89-bit pseudo-random generation Repetition period: 3 x 10 ⁹ years
Carrier-to-noise ratio formats	From front panel: C/N
Carrier-to-noise ratio formats	From Signal Studio Software: C/N, Eb/No, Ec/No

Remote programming

Interfaces	GPIO (IEEE-488.2,1987) with listen and talk, RS-232, and 10BaseT LAN interface
Control languages	SCPI version 1997.0; completely code compatible with previous PSG signal generator models: <ul style="list-style-type: none"> - E8241A - E8244A - E8251A - E8254A - E8247C - E8257C <p>The E8267D will emulate the applicable commands for the following Keysight signal generators, providing general compatibility with ATE systems:</p> <ul style="list-style-type: none"> - 8340-Series (8340/41B) - 8360-Series (836xxB/L) - 83700-Series (837xxB) - 8662A/8663A - 8643A/8644B - 8664A/8665B - Aeroflex 2040
IEEE-488 functions	SH1, AH1, T6, TE0, L4, LE0, SR1, RL1, PP0, DC1, DT0, C0, E2
Keysight I/O libraries	Keysight's I/O Library Suite ships with the E8267D to help you quickly establish an error-free connection between your PC and instruments—regardless of the vendor; it provides robust instrument control and works with the software development environment you choose

General specifications

Power requirements	100/120 VAC 50/60/400 Hz; or 220/240 VAC 50/60 Hz, (automatically selected); < 400 W typ, 650 W maximum
Operating temperature range	0 to 55 °C
Storage temperature range ¹	-40 to 70 °C
Altitude	0 to 4600 m (15,000 ft.)
Humidity	Relative humidity - type tested at 95%, +40°C (non-condensing)
Environmental testing	Samples of this product have been tested in accordance with the Keysight Environmental Test Manual and verified to be robust against the environmental stresses of storage, transportation, and end-use; those stresses include but are not limited to temperature, humidity, shock, vibration, altitude, and power line conditions. Test methods are aligned with IEC 60068-2 and levels are similar to MIL-PRF-28800F Class 3. ²
ISO compliant	This family of signal generators is manufactured in an ISO-9001 registered facility in concurrence with Keysight's commitment to quality
EMC	Conforms to the immunity and emission requirements of IEC/EN 61326-1 including the conducted and radiated emission requirements of CISPR Pub 11/2003 Group 1 Class A.
Acoustic noise	Normal: 53 dBA (nom) Worst case: 62 dBA (nom) ³
Storage	Memory is shared by instrument states, user data files, sweep list files, and waveform sequences. There is 14 MB of flash memory available in the E8267D PSG. With Option 009, there is an additional 8 GB of storage. Depending on how the memory is used, a maximum of 1000 instrument states can be saved.
Security	Display blanking Memory clearing functions (See Application Note, "Security Features of Keysight Technologies Signal Generators," Part Number E4400-90621) With Option 009, all user-written files are stored on an 8 GByte removable flash memory card.
Compatibility	Keysight 83550 Series millimeter heads OML millimeter source modules VDI millimeter frequency extenders Keysight 8757D scalar network analyzers Keysight EPM/EPM-P Series power meters
Self-test	Internal diagnostic routine tests most modules (including microcircuits) in a preset condition. For each module, if its node voltages are within acceptable limits, then the module "passes" the test.
Weight	< 25 kg (54 lb.) net, < 33 kg (74 lb.) shipping
Dimensions	178 mm H x 426 mm W x 515 mm D (7" H x 16.8" W x 20.3" D)
Recommended calibration cycle	24 months

1. During storage below -20 °C, instrument states may be lost.

2. As is the case with all signal generation equipment, phase noise specifications are not warranted in a vibrating environment.

3. This is louder than typical Keysight equipment: 60 dBA (nom).

Input/Output Descriptions

Front panel connectors (All connectors are BNC female unless otherwise noted.)¹

RF output	Output impedance 50 Ω (nom)
Options 513 and 520	Precision APC-3.5 male, or Type-N female with Option 1ED
Options 532 and 544	Precision 2.4 mm male; plus 2.4(f) - 2.4(f) mm and 2.4(f) - 2.9(f) mm adaptors
ALC input	Used for negative external detector leveling. Nominal input impedance 120 k Ω , damage level \pm 15 V
LF output	Outputs the internally generated LF source. Nominal output impedance 50 Ω
External input 1	Drives either AM, FM, or \square M. Nominal input impedance 50 or 600 Ω , damage levels are 5 V _{rms} and 10 V _{peak}
External input 2	Drives either AM, FM, or \square M. Nominal input impedance 50 or 600 Ω , damage levels are 5 V _{rms} and 10 V _{peak}
Pulse/trigger gate input	Accepts input signal for external fast pulse modulation. Also accepts external trigger pulse input for internal pulse modulation. Nominal impedance 50 Ω . Damage levels are 5 V _{rms} and 10 V _{peak}
Pulse video out	Outputs a signal that follows the RF output in all pulse modes. TTL-level compatible, nominal source impedance 50 Ω
Pulse sync out	Outputs a synchronizing pulse, nominally 50 ns width, during internal and triggered pulse modulation. TTL-level compatible, nominal source impedance 50 Ω
Data clock input	Accepts a data clock signal to synchronize serial data for use with internal baseband generator (Option 602) Maximum rate 50 MHz. Damage levels are > +5.5 V and < -0.5 V
Data input	Accepts serial data for use with internal baseband generator (Option 602); maximum rate 50 Mb/s; data must be valid on the falling edges of data clock (normal mode) or the symbol sync (symbol mode); damage levels are > +5.5 V and < -0.5 V
I input	Accepts an "I" input either for I/Q modulation or for wideband AM; nominal input impedance 50 or 600 Ω . Damage levels are 1 V _{rms} and 5 V _{peak}
Q input	Accepts a "Q" input for I/Q modulation; nominal input impedance 50 or 600 Ω . Damage levels are 1 V _{rms} and 5 V _{peak}
Symbol sync input	Accepts symbol sync signal for use with internal baseband generator (Option 602); symbol sync might occur once per symbol or be a single, one bit wide pulse to synchronize the first bit of the first symbol; maximum rate 50 MHz; damage levels are > +5.5 V and < -0.5 V

1. Digital inputs and outputs are 3.3 V CMOS unless indicated otherwise. Inputs will accept 5 V CMOS, 3 V CMOS, or TTL voltage levels.

Rear panel connectors (all connectors are BNC female unless otherwise noted) ¹

Auxiliary interface (dual mode)	Used for RS-232 serial communication and for master/slave source synchronization. (9-pin subminiature female connector). For master/slave operation, use Keysight part number 8120-8806 master/slave interface cable.
GPIO	Allows communication with compatible devices
LAN	Allows 10Base-T LAN communication
10 MHz input	Accepts a 10 MHz external reference (timebase) input. Nominal input impedance 50 Ω Damage levels > +10 dBm
10 MHz output	Outputs internal or external reference signal. Nominal output impedance 50 Ω . Nominal output power +10 dBm.
Sweep output (dual mode)	Supplies a voltage proportional to the RF power or frequency sweep ranging from 0 volts at the start of sweep to +10 volts (nom) at the end of sweep, regardless of sweep width. During CW operation, supplies a voltage proportional to the output frequency, +10 volts (nom) corresponding to the maximum specified frequency. When connected to a Keysight 8757D scalar network analyzer (Option 007), generates a selectable number of equally spaced 1 μ s pulses (nom) across a ramp (analog) sweep. Number of pulses can be set from 101 to 1601 by remote control from the 8757D. Output impedance: < 1 Ω (nom), can drive 2 k Ω .
Stop sweep in/out	Open-collector, TTL-compatible input/output. In ramp sweep operation, provides low level (nominally 0 V) during sweep retrace and bandcross intervals, and high level during the forward portion of the sweep. Sweep will stop when grounded externally; sweep will resume when allowed to go high.
Trigger output (dual mode)	Outputs a TTL signal. High at start of dwell, or when waiting for point trigger; low when dwell is over or point trigger is received. In ramp sweep mode, provides 1601 equally-spaced 1 μ s pulses (nom) across a ramp sweep. When using LF Out, provides 2 μ s pulse at start of LF sweep.
Trigger input	Accepts 3.3V CMOS signal for triggering point-to-point in manual sweep mode, or to trigger start of LF sweep. Damage levels \geq +10 V or \leq -4 V.
Source module interface	Keysight 83550 Series mm source modules: Provides bias, flatness correction and leveling connections. OML SxxMS-AG mm source modules: Provides power to the module and returns frequency multiplication information from the module.
Source settled	Provides an output trigger that indicates when the signal generator has settled to a new frequency or power level. High indicates source not settled, Low indicates source settled.
Z-axis blank/markers	During ramp sweep, supplies +5 V (nom) level during retrace and bandswitch intervals. Supplies -5 V (nom) level when the RF frequency is at a marker frequency.
10 MHz EFC	(Option UNX or UNY) Accepts an external DC voltage, ranging from -5 V to +5 V, for electronic frequency control (EFC) of the internal 10 MHz reference oscillator. This voltage inversely tunes the oscillator about its center frequency approximately -0.07 ppm/V. The nominal input impedance is greater than 1 M Ω .
0.25 – 3.2 GHz coherent carrier output	Outputs RF signal modulated with FM or fM but not I/Q, AM or pulse; nominal power 0 dBm; frequency range from 250 MHz to 3.2 GHz; not useful for output frequency > 3.2 GHz; damage levels 20 VDC and 13 dBm reverse RF power; (SMA female)
Baseband generator clock input	Accepts a sine or square wave PECL clock input with a frequency range of 200 to 400 MHz (resulting in sample rates of 50 MSa/s to 100 MSa/s); the recommended input level is approximately 1 V _{peak-to-peak} for a square wave and 0 dBm to 6 dBm for a sine wave; allows the baseband generators of multiple signal generators to run off the same clock
Burst gate input	Accepts signal for gating burst power for use with internal baseband generator (Option 602); the burst gating is used for externally supplying data and clock information; the input signal must be synchronized with the external data input that will be output during the burst; the burst power envelope and modulated data are internally delayed and re-synchronized; the input signal must be CMOS high for normal burst RF power or CW RF output power and CMOS low for RF off; damage levels are > +5.5 V and < -0.5 V

1. Digital inputs and outputs are 3.3 V CMOS unless indicated otherwise. Inputs will accept 5 V CMOS, 3 V CMOS, or TTL voltage levels.

ALC Hold	This female BNC connector is a TTL-compatible input that controls ALC action with bursted I/Q signals from an arbitrary waveform generator (AWG). A high signal allows the ALC to track the RF signal and maintain constant RF output level as the I/Q inputs vary. A low input signal allows the ALC to be held for a brief time (< 1 s) and not track the RF signal. When driving the external I/Q inputs from an external AWG supplying a bursted waveform, the ALC Hold line should be driven from a marker output from the AWG that is high when the bursted signal is at the proper level and low when the bursted signal is not at the proper level. Damage levels are > 5.5 V and < -0.5 V.
1 GHz Ref Out	This female SMA connector (requires Option UNX or UNY) provides a 1 GHz output that is 100 times the frequency of the internal or external 10 MHz reference. The nominal output impedance is 50 Ω. When not in use, this connector must be terminated with a 50 Ω load.
Coh carrier	This female SMA connector (requires Option UNT) outputs an RF signal that is phase coherent with the signal generator carrier. The coherent carrier outputs RF that is not modulated with AM, pulse, or I/Q modulation, but is modulated with FM or □M (when FM or □M are on). The output power is nominally 0 dBm. The output frequency range is from 249.99900001 MHz to 3.2 GHz. This output is not useful for output frequencies > 3.2 GHz. If the RF output frequency is below 249.99900001 MHz, the coherent carrier output signal will have the following frequency: Frequency of coherent carrier = (1 GHz – Frequency of RF output) Damage levels are 20 V _{DC} and +13 dBm reverse RF power. The nominal output impedance is 50 Ω.
Event 1 output	In real-time mode, outputs a pattern or frame synchronization pulse for triggering or gating external equipment, for use with internal baseband generator (Option 602); may be set to start at the beginning of a pattern, frame, or timeslot and is adjustable to within ± one timeslot with one bit resolution; in arbitrary waveform mode, outputs a timing signal generated by marker 1
Event 2 output	In real-time mode, outputs a data enable signal for gating external equipment, for use with internal baseband generator (Option 602); applicable when external data is clocked into internally generated timeslots; data is enabled when signal is low; in arbitrary waveform mode, outputs a timing signal generated by marker 2
I and Q outputs	Outputs the analog I/Q modulation signals from the internal baseband generator; nominal output impedance 50 Ω, DC-coupled; damage levels ± 3.5 V
I and Q outputs	Outputs the complement of the I and Q signals for differential applications; nominal output impedance 50 Ω, DC-coupled; damage levels ± 3.5 V
Pattern trigger input	Accepts signal to trigger internal pattern or frame generator to start single pattern output, for use with internal baseband generator (Option 602); minimum pulse width 100 ns; damage levels are > +5.5 V and < -0.5 V
Wideband I and Q inputs	Direct differential high-bandwidth analog inputs to I/Q modulator in 3.2 to 44 GHz range and useable for carriers < 3.2 GHz; not calibrated; 0 dBm maximum; (Option 016 only). SMA female connectors.
Removable flash memory drive	Accepts 8 GB compact flash memory card for optional non-volatile memory (Option 009 only); all user information (save/recall settings, flatness files, presets, etc.) is stored on removable memory card when Option 009 is installed

Auxiliary I/O connector (37-pin) used with Option 602

Alternate power input	Accepts CMOS signal for synchronization of external data and alternate power signal timing; damage levels are > +8 V and < -4V
Event 3 output	In arbitrary waveform mode, outputs a timing signal generated by marker 3; damage levels > +8 V and < 4 V
Event 4 output	In arbitrary waveform mode, outputs a timing signal generated by marker 4; damage levels > +8 V and < 4 V
Symbol sync output	Outputs CMOS symbol clock for symbol synchronization, one data clock period wide

Options, Accessories, and Related Products

Model/option	Description
E8267D-513	Frequency range from 250 kHz to 13 GHz
E8267D-520	Frequency range from 250 kHz to 20 GHz
E8267D-532	Frequency range from 250 kHz to 31.8 GHz
E8267D-544	Frequency range from 250 kHz to 44 GHz
E8267D-602	Internal baseband generator, 64 MSa memory
E8267D-003	Digital output connectivity with N5102A
E8267D-004	Digital input connectivity with N5102A
E8267D-007	Analog ramp sweep
E8267D-009	8 GB removable flash memory
E8267D-016	Wideband external I/Q inputs
E8267D-403	Calibrated AWGN
E8267D-409	Global positioning system (GPS) personality
E8267D-423	Scenario generator for GPS personality
E8267D-UNX	Ultra low phase noise
E8267D-UNY	Enhanced ultra low phase noise
E8267D-UNT	AM, FM, phase modulation, and LF output
E8267D-UNU	Pulse modulation
E8267D-UNW	Narrow pulse modulation
E8267D-1ED	Type-N (f) RF output connector
E8267D-1EH	Improved harmonics below 2 GHz
E8267D-1EM	Moves all front panel connectors to the rear panel
E8267D-1CN	Front handle kit
E8267D-1CM	Rackmount flange kit
E8267D-1CP	Rackmount flange and front handle kit
E8267D-UK6	Commercial calibration certificate and test data
E8267D-A6J	Z540-1-1994 calibration
E8267D-AMG	Calibration + uncertainties + guardbanding (accredited)
E8267D-1A7	Calibration + uncertainties + guardbanding
E8267D-CD1	CD-ROM containing the English documentation set
E8267D-ABA	Printed copy of the English documentation set
E8267D-SP2	Dynamic sequencing capability

Application software	
E8267D-SP1	Signal Studio for jitter injection
N7600B	Signal Studio for 3GPP W-CDMA FDD
N7601B	Signal Studio for 3GPP2 CDMA
N7602B	Signal Studio for GSM/Edge
N7606B	Signal Studio for <i>Bluetooth</i> [®]
N7607B	Signal Studio for DFS radar profiles
N7608B	Signal Studio for custom modulation
N7609B	Signal Studio for GNSS
N7610B	Signal Studio for short range communications
N7612B	Signal Studio for TD-SCDMA/HSPA
N7613A	Signal Studio for 802.16-2004 Fixed WiMax [™]
N7614B	Signal Studio for power amplifier test
N7615B	Signal Studio for 802.16 OFDMA Mobile WiMax
N7617B	Signal Studio for 802.11 WLAN
N7620B	Signal Studio for pulse building
N7621B	Signal Studio for multitone distortion testing
N7622B	Signal Studio Toolkit
N7623B	Signal Studio for digital video
N7624B	Signal Studio for 3GPP LTE-FDD
N7625B	Signal Studio for 3GPP LTE-TDD
N6171A	MATLAB software
Customized product solutions	
E8267D-H1S	1 GHz external frequency reference input
E8267D-H1G	Connections for phase coherency and improved phase stability < 250 MHz
E8267D-HCC	Connections for phase coherency > 250 MHz ¹
E8267D-H18	Wideband modulation below 3.2 GHz
Accessories	
U3035P	Distribution network (lock box) ¹
1819-0427	8 GByte compact flash memory card
8120-8806	Master/slave interface cable
N5102A	Digital signal interface module

1. Utilized for multiple source phase coherency applications.

Related Keysight Literature

Keysight Microwave Signal Generators Brochure,
Literature number 5991-4876EN

E8267D PSG Vector Signal Generator
Configuration Guide, Literature number 5989-1326EN

E8257D PSG Analog Signal Generator
Data Sheet, Literature number 5989-0698EN
Configuration Guide, Literature number 5989-1325EN

E8663D PSG RF Analog Signal Generator
Data Sheet, Literature number 5990-4136EN
Configuration Guide, Literature number 5990-4137EN

PSG Two-tone and Multitone Personalities
Application Note AN 1410, Literature number 5988-7689EN

Keysight I/Q Modulation Considerations for PSG Vector Signal Generators
Application Note, Literature number 5989-7057EN

Baseband Studio Digital Signal Interface Module
Technical Overview, Literature number 5988-9495EN

Security Features of Keysight Technologies Signal Generators
Part Number E4400-90621

Web Resources

For additional product information, visit:

www.keysight.com/find/psg

For accessory information, visit:

www.keysight.com/find/accessories

For additional description of Keysight's IO Libraries Suite
features and installation requirements, please go to:

www.keysight.com/find/iosuite/database

From Hewlett-Packard through Agilent to Keysight

For more than 75 years, we've been helping you unlock measurement insights. Our unique combination of hardware, software and people can help you reach your next breakthrough. **Unlocking measurement insights since 1939.**

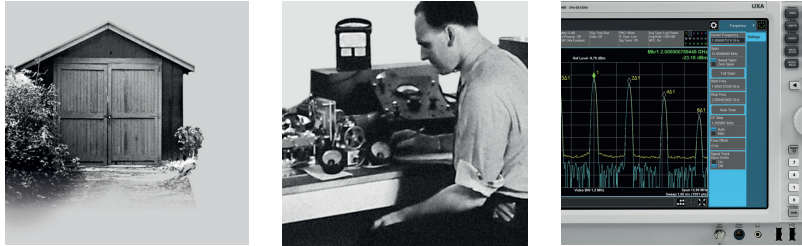

1939

THE FUTURE

myKeysight

myKeysight

www.keysight.com/find/mykeysight

A personalized view into the information most relevant to you.



Three-Year Warranty

www.keysight.com/find/ThreeYearWarranty

Keysight's committed to superior product quality and lower total cost of ownership. Keysight is the only test and measurement company with a three-year warranty standard on all instruments, worldwide. And, we provide a one-year warranty on many accessories, calibration devices, systems and custom products.



Keysight Assurance Plans

www.keysight.com/find/AssurancePlans

Up to ten years of protection and no budgetary surprises to ensure your instruments are operating to specification, so you can rely on accurate measurements.

Keysight Infoline

www.keysight.com/find/service

Keysight Infoline

Keysight's insight to best in class information management. Free access to your Keysight equipment company reports and e-library.

Keysight Channel Partners

www.keysight.com/find/channelpartners

Get the best of both worlds: Keysight's measurement expertise and product breadth, combined with channel partner convenience.

WiMAX™ is a trademark of the WiMAX Forum®.

Bluetooth and the Bluetooth logos are trademarks owned by Bluetooth SIG, Inc, U.S.A. and licensed to Keysight Technologies, Inc.

www.keysight.com/find/E8267D

For more information on Keysight Technologies' products, applications or services, please contact your local Keysight office. The complete list is available at: www.keysight.com/find/contactus

Americas

Canada	(877) 894 4414
Brazil	55 11 3351 7010
Mexico	001 800 254 2440
United States	(800) 829 4444

Asia Pacific

Australia	1 800 629 485
China	800 810 0189
Hong Kong	800 938 693
India	1 800 11 2626
Japan	0120 (421) 345
Korea	080 769 0800
Malaysia	1 800 888 848
Singapore	1 800 375 8100
Taiwan	0800 047 866
Other AP Countries	(65) 6375 8100

Europe & Middle East

Austria	0800 001122
Belgium	0800 58580
Finland	0800 523252
France	0805 980333
Germany	0800 6270999
Ireland	1800 832700
Israel	1 809 343051
Italy	800 599100
Luxembourg	+32 800 58580
Netherlands	0800 0233200
Russia	8800 5009286
Spain	800 000154
Sweden	0200 882255
Switzerland	0800 805353
	Opt. 1 (DE)
	Opt. 2 (FR)
	Opt. 3 (IT)
United Kingdom	0800 0260637

For other unlisted countries:
www.keysight.com/find/contactus
(BP-01-01-16)



www.keysight.com/go/quality

Keysight Technologies, Inc.
DEKRA Certified ISO 9001:2008
Quality Management System